



Revolutionize your lifestyle with water

Change your water... **change** your **body**
Eco-friendly daily water

High performance with seven electrode plates

Equipped with a built-in electrolysis enhancer tank

You will be prompted by a voice and large LCD display

The power of Kangen water preserves your body and the environment !

Leveluk^{SD} 501

Continuous Ionized Electrolysis Water Generator

Approved as a Medical Device by the Japanese Ministry of Labor and Welfare.



FIVE TYPES OF WATER MAKII

Sanitary water



Strong acidic water has excellent disinfecting power that can prevent food poisoning. Use it to clean and sterilize your foodstuff, dishes, and cookware.

- To sanitize your knives, cutting boards or dish towels
- To sterilize your fingers.
- To disinfect your toothbrushes or to brush your teeth
- To clean your skin
- To remove tea incrustations



Strong Acidic Water

below pH2.7 ⚠️*not suitable for drinking

STRONG ACID button  from the secondary hose

At the same time, Strong Kangen Water will be released from the flexible pipe.

Environment friendly water



Strong kangen water, which is certainly water but has a strong cleaning effect as a detergent, preserves hygiene in your daily life.

- To clean cutting boards, knives, and dishes.
- To sterilize vegetables, meat, and fresh fish.
- To remove slime and stains on the floor.
- To remove stains from the toilet.
- To remove spots from coffee, soy sauce, and edible fat.
- To use for washing clothes in order to reduce the consumption of detergent.
- To remove the harshness of wild plants such as bamboo shoots, brackens or flowering ferns.

※ It will be still more effective to clean with strong acidic water after cleaning with strong kangen water.

Strong Kangen Water

over pH11.0 ⚠️*not suitable for drinking

STRONG ACID button  from the flexible pipe

At the same time, Strong Acidic Water will be released from the secondary hose.



NG YOUR BODY, YOUR LIFE, AND YOU

Healthy water

Kangen Water

pH8.0-10.0 suitable for drinking

KANGEN button  from the flexible pipe

At the same time, Acid Water will be released from the secondary hose.

swelling effect

It has the power to soften substances.

Dissolving effect

It dissolves and draws out substances.

Thermal conduction

It doesn't take a long time to boil.

Kangen water makes your drinking water and dishes delicious.

● To cook rice

If you use kangen water to rinse or to boil rice, the rice will come out nice and fluffy.

If you use new rice, it will be fluffy even if you start to cook the rice immediately after you rinse it.

● With coffee, tea, or green tea

For which taste and aroma are everything, you will be surprised at the improved color, taste, and aroma. And you can use less coffee, tea, or green tea, and still achieve a full rich taste due to its extractive ability.

● With other strongly acidic foods

Drink Kangen Water together with strongly acidic foods such as meat, egg yolks, and the like; the alkaline water will help your body balance the acidic effects of those foods.

Others; For hangover, cold sweats after drinking too much, making stocks, and making beans.

● In soups and stews

It draws out the natural flavor of ingredients so they cook up tender and juicy. Therefore, seasonings such as salt and soy sauce are needed in smaller amounts, perfect for people trying to reduce their salt intake.

● Use for blanching vegetables

Use it to remove rawness of onions, bamboo shoots, burdock, or the like.



What to know about Strong Acidic water, Strong Kangen Water

What is Strong Acidic Water?

Strong Acidic Water is a kind of electrolyzed water with electrical potential that contains hypochlorous acid produced at the anode when an electrolysis enhancer is added to the original water and electrolysis occurs, but it is not a strongly acidic chemical substance. In general, the pH is below 2.7, and the ORP is over

What is Strong Kangen Water?

Strong Kangen Water is a kind of electrolyzed water with electrical potential that contains sodium hydroxide produced at the cathode when an electrolysis enhancer is added to the original water and electrolysis occurs, but it is not a strong alkaline chemical substance. In general, the pH is over 11.0, and the ORP is be-

※ What is ORP (Oxidation Reduction Potential) ?

It is a value that shows the proportion of oxidizing ions (such as chloride ion) and reduction ions (such as calcium ion) in a substance that takes the form of solution. If this value is shown as minus as compared with the reference value, the substance reduces other substances, and can easily be oxidized itself. If this value is shown as a plus compared with the reference value, the substance oxidizes others and it can be easily reduced. The unit is most often shown in mV(millivolt), and it is used as an index that

Water for beauty

Astringency

It has the power to tighten substances.

Cleaning power

It has the power to purify substances.

Weak acidic water used for beauty

Acidic water is recognized to have an effect to tone your skin. It is effective to help tone your skin after a bath or shower, or to help close your pores after washing your face.

In boiling pasta and batters for fried foods

All types of noodles and pasta come out with a nice sheen and firm texture. It will also give you extra crispy fried foods, which won't hold so much oil.

For cleaning water

You can well remove stains on dishes, cups, glasses, and tiles.

Beauty Water

pH4.0-6.0 ⚠️*not suitable for drinking

ACID button  from the flexible pipe

At the same time, Kangen Water will be released from the secondary hose.

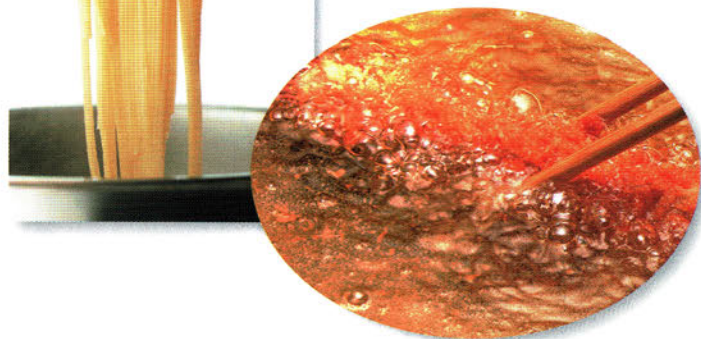

Water for security

When taking medication or in baby formula

The three-layered, high-powered, water-cleaning filter removes not only chlorine but also matters such as rust, impurities, and lead, and you will obtain delicious clean water that contains minerals.

Don't forget to use clean water when you prepare your baby's formula or when you take medication.

Clean water

pH7.0 suitable for drinking

CLEAN WATER button  from the flexible pipe

At the same time, the secondary hose also releases purified water, but please use the water released from the flexible pipe.



It has **seven electrode plates** to ensure sufficient power.
It is **easy to use** and compactly designed.

Point

1

The electrolytic cell is equipped with **seven electrode plates**, which is powerful and compactly designed.

It is possible to produce a good amount of electrolyzed water of which the value of ORP is included in the range of +1130mV and -800mV and which boasts of good effects, by loading an electrolytic cell with seven electrode plates that use electrodes made of platinum plated titanium. (That depends on the choice of resulting water and original water)
The Kangen water contains a lot of hydroxide ions (OH-) and positive ions (such as calcium ions) produced by electrolysis, and it also contains hydrogen.

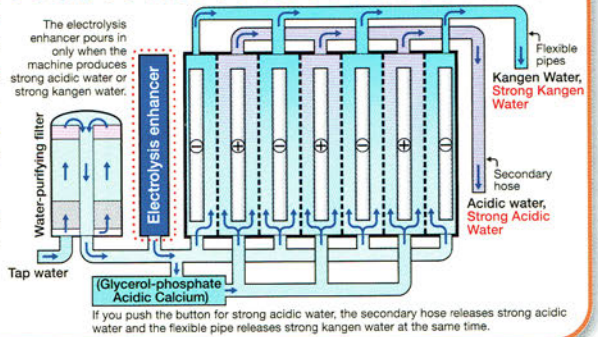

Point

2

Equipped with an electrolysis enhancer tank
Strong Acidic Water and Strong Kangen Water produced steadily and continuously.

The built-in tank for the electrolysis enhancer saves you the trouble of putting in the electrolysis enhancer which is necessary to obtain strong acid water and strong kangen water, and allows you to produce those kinds of water steadily and continuously that has excellent effects.
An injection of electrolysis enhancer 400g produces around 20~30 Liters of strong acidic water in around thirty minutes (this figure depends on the water quality).



Point

3

You will be notified by a **large-sized liquid crystal display (LCD)** and the **voice prompted guide.**

Easy to use one-touch panel.

A clear, large-sized LCD and the voice prompts will inform you of the kind of water being produced (kangen water, acidic water, strong acidic water*, or purified water) and necessary information.
The operation is very easy, because you only need to touch a button in order to power up or down or to select the type of water you would like to obtain.

* When you push the button for strong acidic water, the secondary hose releases strong acidic water and the flexible pipe releases strong kangen water at the same time.

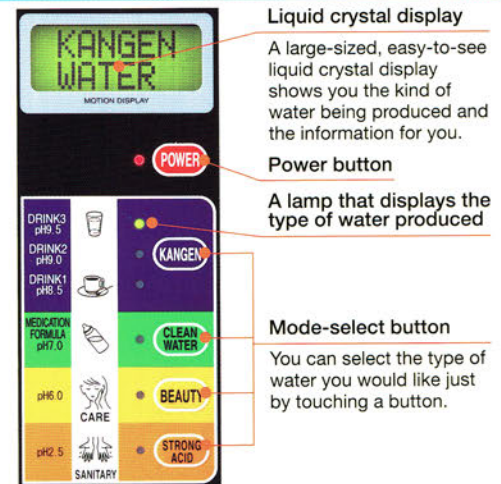

The three-layered, high-powered water-cleaning filter creating delicious water

You will be able to use your water-cleaning filter until the total amount of water the filter has treated reaches around 6000 Liters. That is to say, you can use it for six months supposing you use around 32 Liters of water per day. (This period differs depending on the quality and amount of water). It will be announced by the LCD, voice prompts, and alarm when it is time to exchange the filter.
The three-layered, high-powered water-cleaning filter removes matters such as lead, remaining chlorine (bleaching powder), effluvium, rust, and impurity, and still keeps minerals.

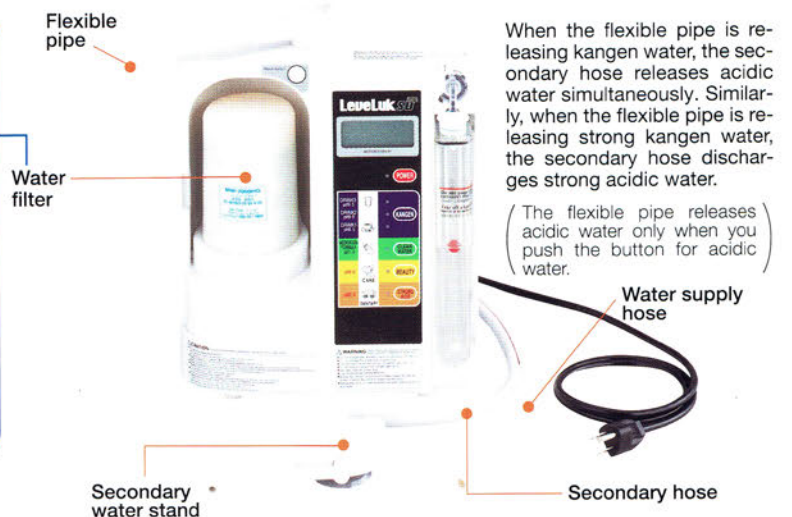
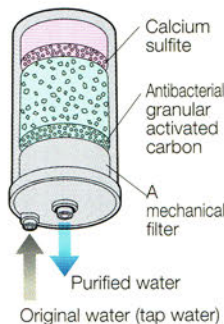

A five-year warranty will bring you relief and confidence.

With the one-touch convenience of the diverter, change between



ION
Clean Water



TAP Water
(Shower)



TAP Water

NO SPECIAL INSTALLATION REQUIRED. The diverter included with unit will fit almost any type of faucet.

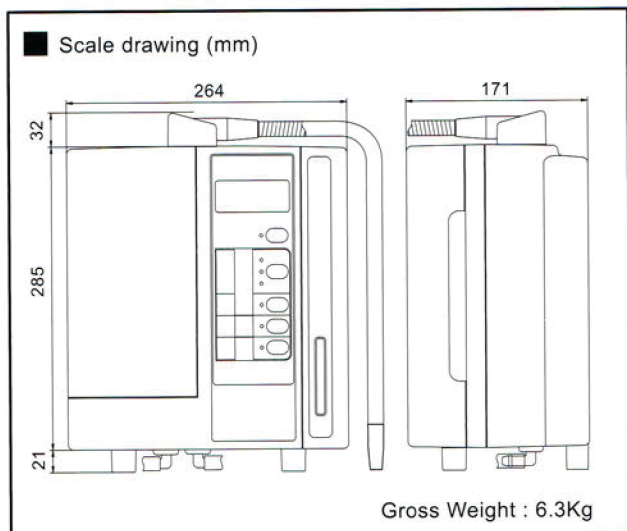

ISO 9001 REGISTERED FIRM

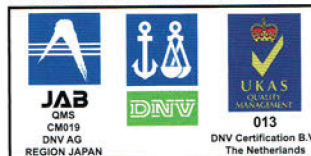

ISO 13485 CERTIFIED COMPANY



ISO 14001 REGISTERED FIRM



ENAGIC INC. ISO 9001:2008
Obtained ISO 14001:2004
ISO 13485:2005

Standard Specifications

MODEL NAME · NUMBER	LevelLuk SD 501	WATER FILTER	FILTERING MEDIUM	Anti-bacterial Granular Activated Charcoal & Sulfurous Acidic Calcium	Strong Acidic water
WATER SOURCE CONNECTION	1-way diverter (TAP/ION) connects to end of faucet		FILTRATION ABILITY	FREE RESIDUAL CHROLINE INITIAL CHROLINE REMOVAL	
POWER SUPPLY	AC 220V, 50Hz	ELEMENTS NOT REMOVABLE		Metallic ions and/or salinity present in original (tap) water	
POWER CONSUMPTION	Approximately 230W (under maximum electrolysis function)	Time to exchange the filter		When the filter has treated over 6000 Liters of water (this figure depends on the quality of water)	
SYSTEM	Continuous Ionized Electrolysis Water Generator System (with built-in flow rate sensor)	APPLICABLE WATER QUALITY AND PRESSURE		Municipally supplied drinking water: Dynamic range in 0.05~0.45MPa	
PRODUCTION RATE (liter(s)/minute)	Kangen Water : 4.5 ~ 7.5L Beauty Water : 1.5 ~ 2.5L Strong Acidic Water : 0.6 ~ 1.2L	ELECTROLYSIS ENHANCER		Solution additive pump system	
LEVEL SELECTIONS	●Kangen water / 3 levels (approx. pH8.5~9.5) ●Clean water (neutral) ●Beauty water (approx. pH5.5~6.5) ●Strong Acidic water (approx. pH2.4~2.7) / Strong Kangen water (approx. pH11.0~)	ENHANCER REFILLING		Indicates by voice, alarm and LCD	
ELECTROLYSIS CAPABILITY UNDER CONTINUOUS USE	Approx. 60 min. at normal room temperature.	PROTECTOR		Current Limiter/Voltage Stabilizer/Thermal Protection	
CELL CLEANING METHOD	Auto cleaning System (periodically controlled by microcomputer).	【 Option Items 】			
ELECTRODE MATERIAL	Platinum-plated Titanium	<ul style="list-style-type: none"> ■ Water Filter for replacement ● High-Grade type for Chlorine & Lead (pb) removal ■ Glycerol-phosphate Acidic Calcium ■ Electrolysis Enhancer ■ E-Cleaner Set ■ Cleaning Powder 			

SAFETY PRECAUTIONS For your own safety, be sure to observe the following precautions

⚠ WARNING

- Please read the Operation Manual carefully, and then use according to instructions.
- Pay attention to the following points before consuming ionized alkaline water (KANGEN WATER) produced by the water production unit.
 - (1) Do not take medicine with KANGEN WATER.
 - (2) Those who have anoxia problem should not take KANGEN WATER.
 - (3) Those who are feeling some abnormality after drinking KANGEN WATER, or those who don't show any improvement in symptoms even after regular use of it, should consult a doctor or a pharmacist before continuing consumption of KANGEN WATER.
- Those who are under a doctor's care, or those who are feeling some abnormality in the body, should consult a doctor or a pharmacist before drinking KANGEN WATER.
- Those who have sensitive skin or allergies should consult a doctor or a pharmacist before use of Acidic Water as an astringent.
- Those who are feeling discomfort or irritation with Acidic Water for skin care, please discontinue use and consult a doctor.

⚠ CAUTION

- Those who drink it for the first time.
- We would recommend you to start drinking it at lower pH level of pH8.5 with a daily consumption of 1~2 glasses of it a day continued for about 2 weeks to get used to Kangen water. Then, gradually increase the pH level.
- In case some rash or the like has appeared after drinking it.
- A person who has allergic reaction to some food may experience rash or similar symptoms. Discontinue drinking it, and consult a doctor.
- All the goods described in this catalogue should be used only in Asia.
- Use municipally treated water with drinking safe quality. (Tap water or the like)

- The specifications or appearance of the product are subject to manufacturer's improvements without prior notice.
- Please be aware of that actual product may differ slightly in color, etc from that seen in print.
- For more information about the product, please inquire with the sales dealer in your district or area.
- Every product has an accompanying warranty card, which shall be filled in and issued by the Representative Sales Firm. Please check the contents and keep it in safe place for later use during the period of warranty.

ATC GROUP LIMITED

Santa Leung (梁先生)

9789-1357

santaleung@atceng.hk

atceng.hk